

DIGITAL CLAM

MAXX[®] CLAM

OPERATOR'S MANUAL



Available models: MAXX[®] Clam
28 x 38 cm, 38 x 38 cm, 40 x 50 cm (shown)

STAHL'S
Hotronix[®]

When using your heat press, basic precautions should always be followed, including the following:

1. Read all instructions.
2. Use heat press only for its intended use.
3. To reduce the risk of electric shock, do not immerse the heat press in water or other liquids.
4. Never pull cord to disconnect from outlet, instead grasp plug and pull to disconnect.
5. Do not allow cord to touch hot surfaces, allow heat press to cool completely before storing.
6. Do not operate heat press with a damaged cord or if the equipment has been dropped or damaged. To reduce the risk of electric shock, do not disassemble or attempt to repair the heat press. Take it to a qualified service person for examination and repair. Incorrect assembly or repair could increase the risk of fire, electric shock, or injury to persons when the equipment is used. Power supply cord must be disconnected before cleaning or servicing press.
7. This appliance is not intended for use by persons (including children) with reduced physical, sensory or mental capabilities, or lack of experience and knowledge, unless they have been given supervision or instruction concerning use of the appliance by a person responsible for their safety.
8. Close supervision is necessary for any heat press being used by or near children. Do not leave equipment unattended while connected.
9. To avoid burns, do not touch hot metal parts or the heated platen during use.
10. To reduce the likelihood of circuit overload, do not operate other high voltage equipment on the same circuit.
11. If an extension cord is necessary, then a 20-ampere rated cord should be used. Cords rated for less amperage may overheat. Care should be taken to arrange the cord so that it cannot be pulled or tripped over.
12. Keep hands clear of the upper heat press platen during lock down as the pressure may cause injury.
13. Heat press should be placed on a sturdy, suitable stand at least 36"L x 24"W x 29"H.
14. Work area must be kept clean, tidy and free of obstructions.

Table Of Contents

Safety Instructions	2
Machine View	4
Control Panel Guide	5
Operating Instructions	6-8
Connecting the System	6
Start Up/Shut Down	6
Adjusting Temperature	7
Adjusting Time	7
Adjusting Pressure	8
Printing/Pressing	8
Electrical Schematic	9
Parts Location Guide	10
Replacement Parts List	11
Contact	12



Rückansicht der Presse

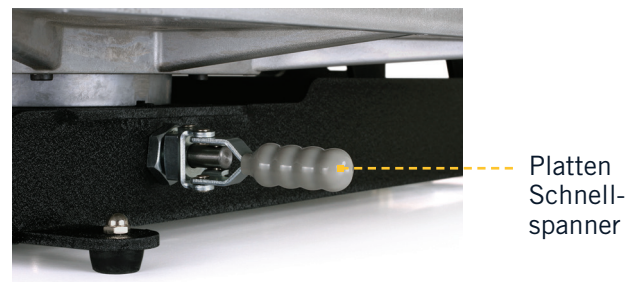

Ansicht von unten

Control Panel Guide

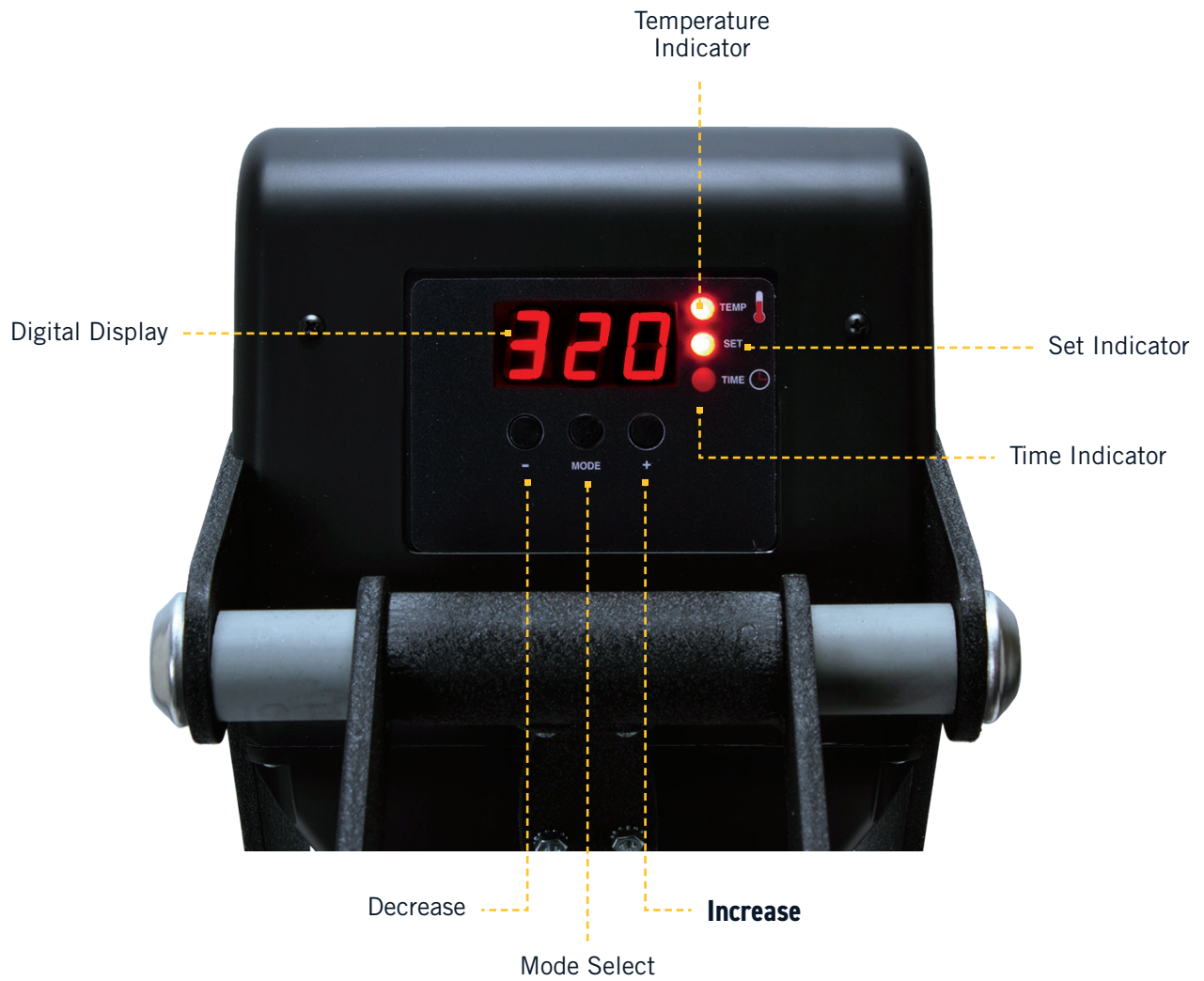

Connecting the System



Connect the power cord into a properly grounded electrical outlet with a sufficient amperage rating.

Voltage

120 volt requires a full 20-amp grounded circuit.

240 volt requires a full 10-amp grounded circuit.

Extension Cords should be as short as possible and not less than 12 gauge. Heavy duty cords are recommended.

Circuits with less than 15 amps or that have other high demand equipment or heat presses plugged in should not be used.

Note: If the supply cord is damaged, it must be replaced by the manufacturer, its service agent or a similarly qualified person in order to avoid hazard. Use SJT type rated 300 V cord for replacement.

CAUTION

Failure to follow these instructions will cause:

1. Erratic controller functions.
2. Inaccurate displays and slow heat up.
3. The circuit breaker to disengage.

Start Up/Shut Down



Locate the lift handle and position the heat platen in the UP position.



Locate the Power ON/OFF Switch on the side of the press, then turn the Power Switch ON.

Adjusting Temperature



Press the Mode Select button in the center of the Control Panel.

The (SET) and (TEMP) lights located next to the display will illuminate.

Press the (+) or (-) button to raise or lower the temperature setting.

The temperature can be set from 205°F (96°C) to 430°F (220°C). The LED Display will show changes as you make them.

Note: The temperature indicator will only display temperatures 200°F (93°C) and up.

Adjusting Time



Once you have adjusted the temperature, press the Mode Select button again to advance to Time Mode.

The (SET) and (TIME) lights will illuminate.

Adjust the time in the same manner you adjusted the temperature.

Select the desired time and push the Mode Select button again to exit.

All lights will be off and the press will return to PRINT mode.

Adjusting Pressure

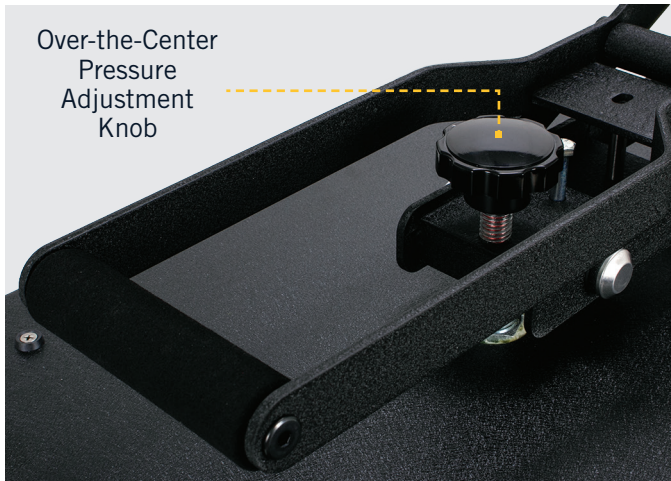

The MAXX[®] Clam Press features a patented, over-the-center pressure adjustment located in the center of the heat platen.

Turn the knob clockwise to increase pressure and counterclockwise to decrease pressure.

Remember to allow for the thickness of your garment when adjusting the pressure.

WARNING: Structural damage caused by excessive pressure is not covered under the limited warranty!

Printing/Pressing



Once your equipment has reached the designated temperature:

- Position the garment and design
- Lower and lock the heat platen into the PRESS position to begin the automatic timing process
- The timer will automatically count down and audibly signal you to lift the heat platen into the UP position when the print cycle is complete

Electrical Schematic

US 120V/240V Versions

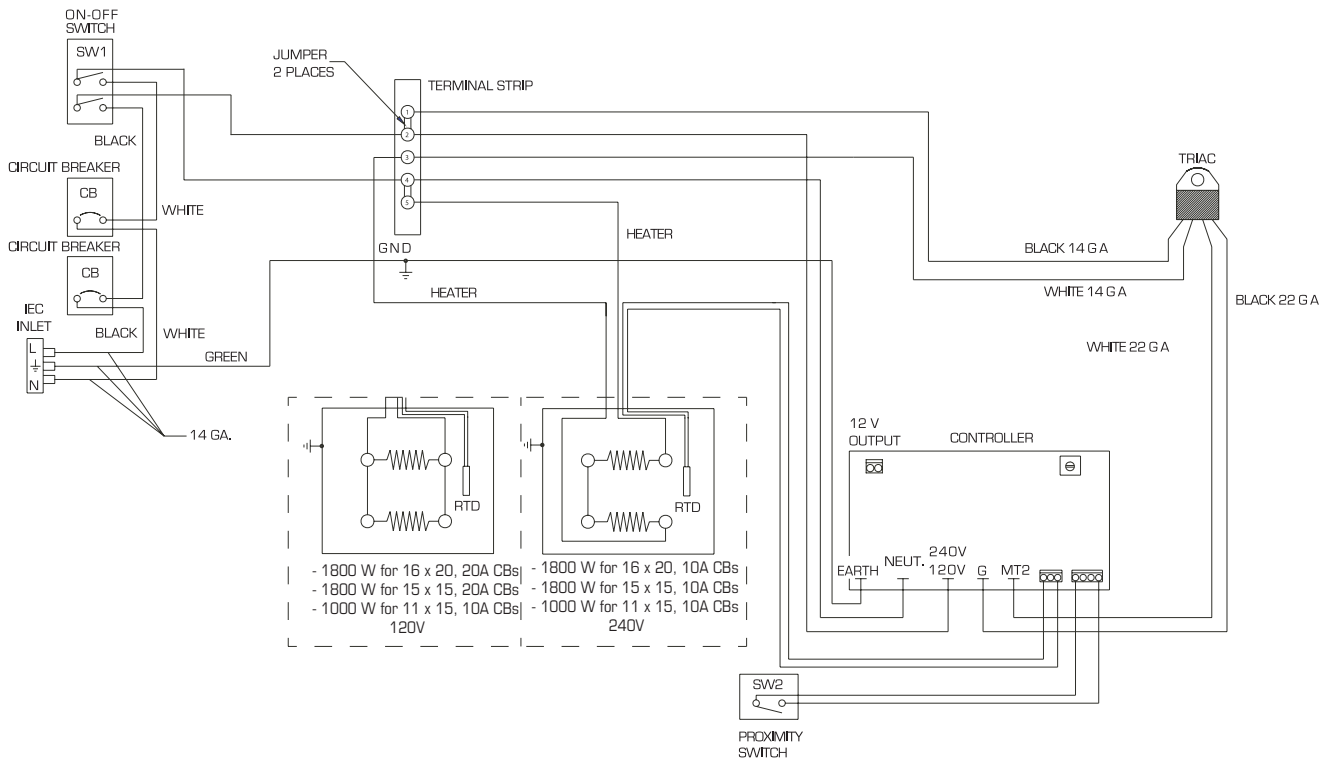

CE 230 V Version

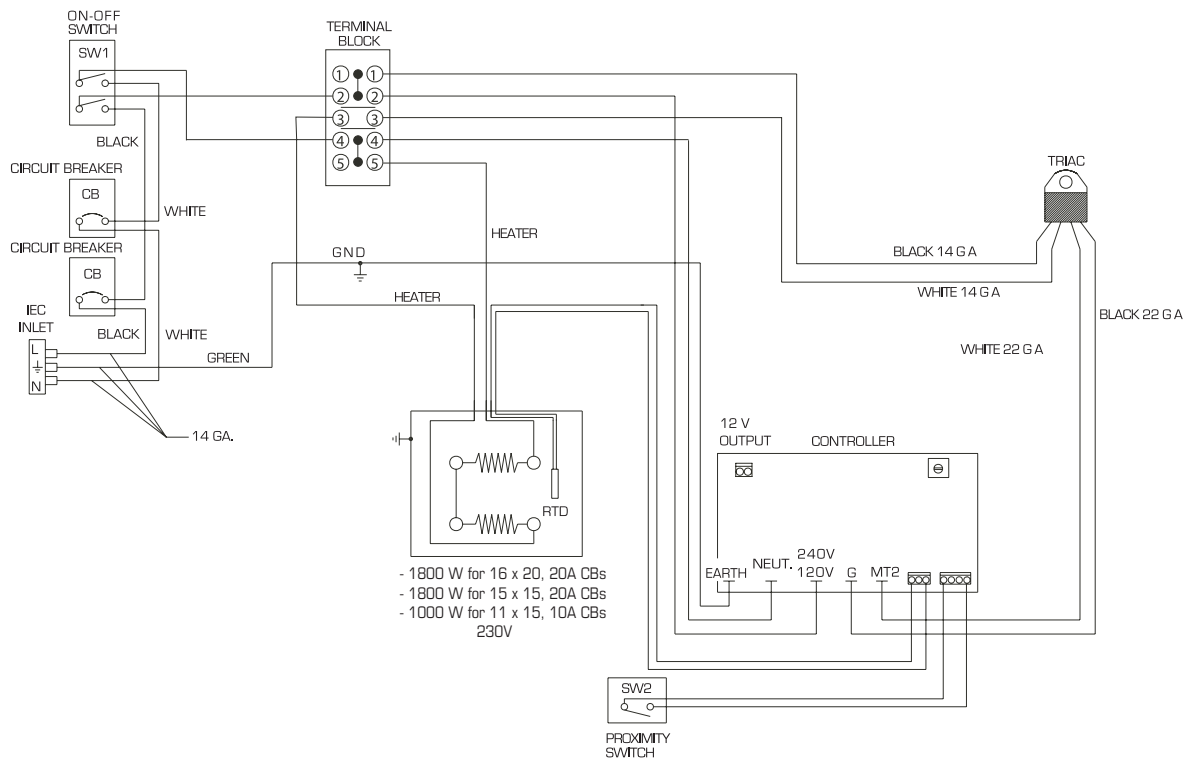

The MAXX™ Press Digital Clam is available in three sizes: 28 x 38 cm, 38 x 38 cm, 40 x 50 cm

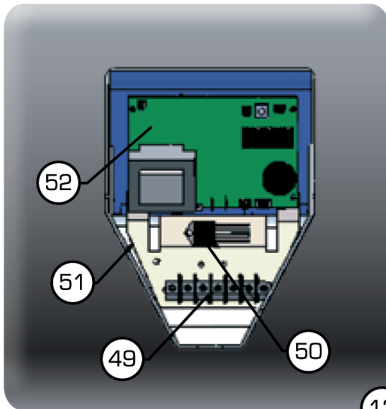

When ordering replacement parts, refer to the following color codes

For a 28 x 38 cm press - use colour code **A**

For a 38 x 38 cm press - use colour code **B**

For a 40 x 50 cm press - use colour code **C**

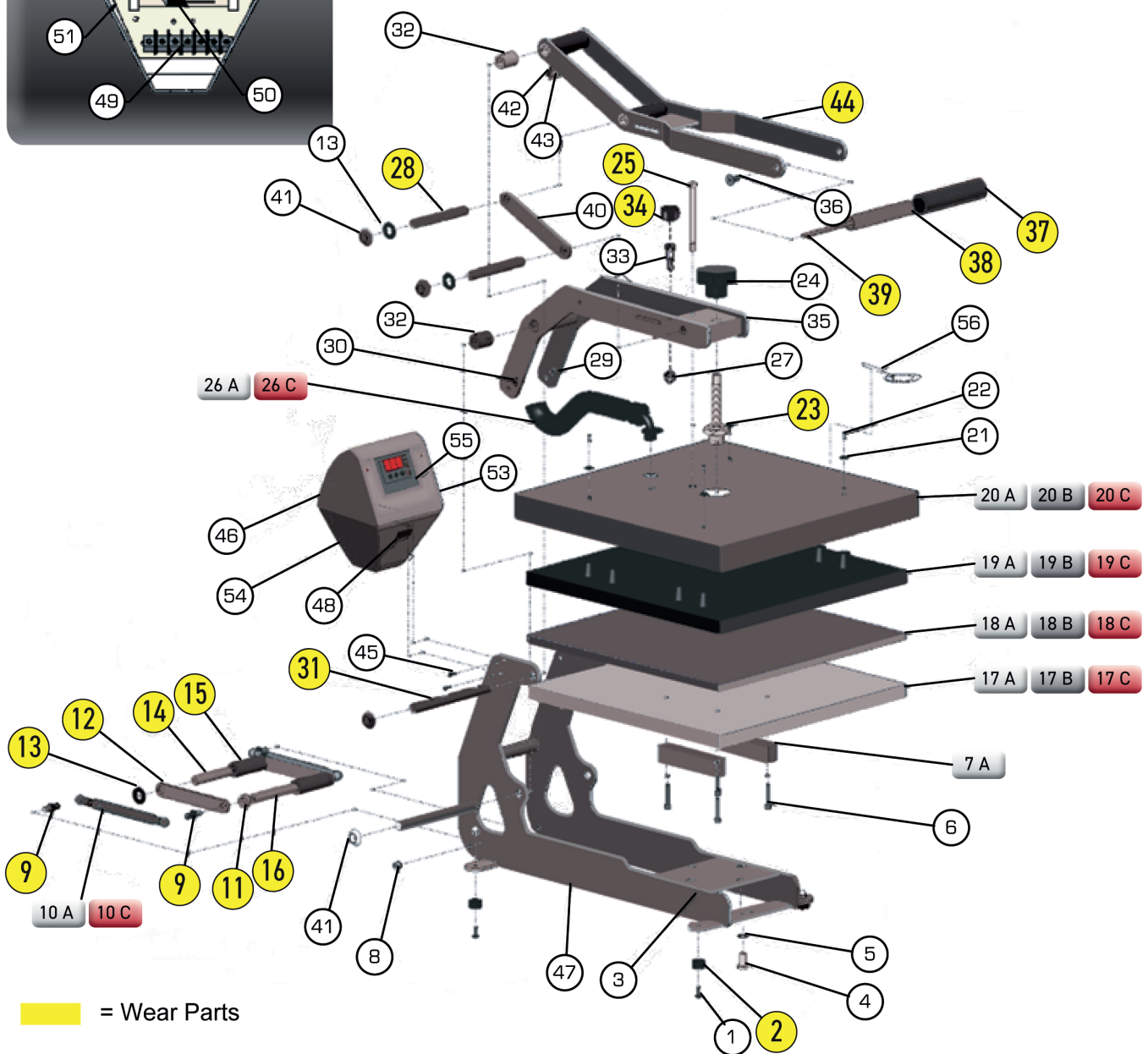

Replacement Parts List

Item #	Part Name	Part #	Qty.
1	Hex Soc Button HD # 10 - 32 x 1/2"	3 - 1011 - 164	4
2	Rubber Foot	1 - 1256	4
3	Acorn Hex Nut	3 - 1011 - 182	4
4 A-B	Hex Cap HD Screw - 3/8" -16 x 3/4"	16 x 20 15 x 15 3 - 1011 - 41	2
5	Lock Spring Washer	2 - 1006 - 43	2
6	Hex Soc Screw 1/4 - 20 x 1 1/4"	3 - 1011 - 62	4
7 A-B	Lower Platen Spacer	16 x 20 15 x 15 1 - 1279	2
7 C	Lower Platen Spacer	11 x 15 0140	1
8	Nylon Hex Nut	2 - 1006 - 20	2
9	Ball Stud - 10mm	1 - 1939	4
10 A	Gas Spring	16 x 20 1 - 2086	2
10 B-C	Gas Spring	15 x 15 11 x 15 1 - 1874	2
11	Steel Spacer	1 - 2114	2
12	Bridle Links	KIT 3 - 6906	2
13	Nylon Washer	1 - 1048 - 3	6
14	Threaded Pin 1/4" - 20 x 3"	1 - 2091	1
15	PVC Spacer 1/2" I.D. x 2.48	1 - 2098	1
16	Threaded Pin 3 5/8" x .5" Dia. 1/4" - 20	1 - 2092	1
17 A	Lower Platen	16 x 20 2 - 1029	1
17 B	Lower Platen	15 x 15 3 - 1086	1
17 C	Lower Platen	11 x 15 3 - 1199 - 1	1
18 A	Silicone Pad Gray	16 x 20 1 - 1011	1
18 B	Silicone Pad Gray	15 x 15 1 - 1473	1
18 C	Silicone Pad Gray	11 x 15 1 - 1875	1
19 A	Heat Platen	16 x 20 2 - 1002 - 3	1
19 B	Heat Platen	15 x 15 3 - 1320	1
19 C	Heat Platen	11 x 15 3 - 1199	1
20 A	Heat Platen Cover	16 x 20 3 - 1332	1
20 B	Heat Platen Cover	15 x 15 3-1337	1
20 C	Heat Platen Cover	11 x 15 3 - 1331	1
21	Finish Washer	1 - 1063	4
22	Cover Screw 10 - 24 x 1/2"	3 - 1011 - 217	4
23	Adjustment Spindle	2 - 1081	1
24	Pressure Adj. Knob	1 - 1012	1
25	Safety Bolt " - 18 x 4 1/2"	3 - 1011 - 238	1
26 A-B	Elbow 90 degress with tubing	16 x 20 15 x 15 1 - 1940	1
26 C	Topaz Connector with flex tubing	11 x 15 1 - 1353	1
27	Shoulder Bolt	3 - 1011 - 55	1
28	Steel Pin 1/2" Dia. x 4.38	1 - 2093	2
29	Soc HD Cap Screw 1/4" - 20 x 3/8"	3 - 1011 - 215	2
30	Hex HD Nut - 1/4 " - 20	2 - 1006 - 12	2
31	Steel Pin - 1/2" Dia. x 6.45	1 - 2094	2
32	PVC Spacer - 1/2" I.D. x 1.1	1 - 2097	4
33	Nylon Nut	2 - 1006 - 20	1
34	Rubber Foot	1 - 1256	1
35 A-B-C	Adjustment Arm Assembly	16 x 20 15 x 15 11 x 15 KIT 3 - 6903	1
36	JCN Nut	2 - 1006 - 2	2
37	Foam Grip	1-1540	1
38	PVC Spacer 1/2" I.D. x 5"	1 - 2096	1
39	All Thread Pin - 1/4" - 20 x 4 3/4"	1 - 1042 - 1	1
40	Lift Links	KIT 3 - 6905	2
41	Hucap 1/2"	1 - 1107 - 1	8
42	Magnet	1 - 1219	1
43	Magnet Bracket	1 - 2085	1
44 A-B-C	Handle Assembly	16 x 20 15 x 15 11 x 15 KIT 3 - 6904	1
45	Phillips Pan HD Screw - #6-32 x 1/2"	3 - 1011 - 152	4
46	Housing	4 - 1172	1
47 A-B-C	Base Assembly	16 x 20 15 x 15 11 x 15 KIT 3 - 6901	1
48	Proximity Switch	1 - 1211	1
49	Terminal Block	1 - 1290	1
50	Triac	1 - 1059	1
51	Controllor Bracket	2 - 1661	1
52	SSTT Control Board	1 - 2017	1
53	On/Off Switch	1 - 2087	1
54	Circuit Breaker	1 - 1331	1
55	Display Overlay	1 - 2018	1
56	Probe	1 - 1272 - 1	1

 = Verschleißteile/Wear Parts

CONTACT US

STAHL'S' Asia

8-79, Samseong 3-gil

Dongnam-gu
Cheonan-si
Chungcheongnam-do

Rep. of Korea

Technical Support & Customer Service

+82 41 622 0936

Email

info@stahlsasia.com

Web

stahlsasia.com

